

### ■ ADVANTAGE

- Wattage switchable : 45W/60W/80W  
60W/80W/100W 80W/100W/120W
- CCT switchable: 3500K/4000K/5000K
- 0-10V dimmable
- Waterproof: IP65
- PF>0.90 , CRI>80
- Input voltage: AC120-277V
- Lumen : 140Lm/W
- Application: carports, loading areas, driveways, parking areas etc



### ■ DETAILS

#### Features

- Solid structure.
- Glass cover hidden screw design.
- Wattage and CCT switchable through dip-switches.
- Super bright LED Chips to assure uniform and efficiency light output.
- Excellent thermal management system.
- Large Illumination Range perfect for outdoor environment.

#### Accessories

- Motion sensor, wire guard and photocell for option.

#### Certifications

- DLC 5.1 premium.
- Comply with the requirements of the Standard(s) for Luminaires and are identified with the cETL Listed Mark.

#### Warranty

- All products from DIMI LIGHT are guaranteed with 5 years' warranty.
- See [Warranty policy from DIMI LIGHT](#) for additional information.

### ■ DIMENSIONS

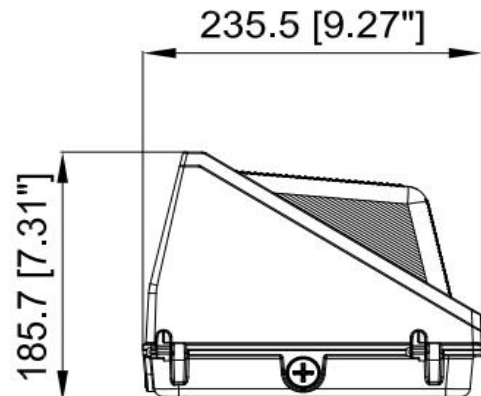
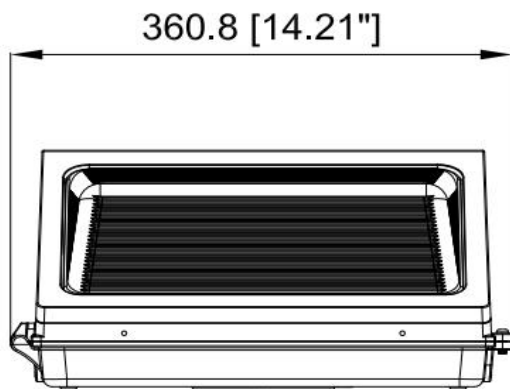

## ■ SPECIFICATION

	MODEL	WATT	CCT	EFFICACY
<input type="checkbox"/>	DM-WP45/60/80W-3545K-A	45W/60W/80W switchable	3500K/4000K/5000K switchable	140Lm/W
<input type="checkbox"/>	DM-WP60/80/100W-3545K-A	60W/80W/100W switchable	3500K/4000K/5000K switchable	140Lm/W
<input type="checkbox"/>	DM-WP80/100/120W-3545K-A	80W/100W/120W switchable	3500K/4000K/5000K switchable	140Lm/W

## ■ ACCESSORIES (order separately)

Wire Guard

Button Type Photocell



### Button Type Photocell

- IP65 protection rating for outdoor use.
- AUTO ON/OFF - automatically turn the lights on at dusk and off at dawn.
- High quality material shell protects the photocell against damaged by rain or dust, assures long-term using.



### Wire Guard

- To protect the glass cover from impact of external force.
- Perfect fit for wall pack
- Material: Steel

## ■ PACKING INFO

4PCS/CARTON (1PC/BOX)			PALLET		CONTAINER		
DIMENSION(INCH)	N.W(LBS)	G.W(LBS)	PCS	CTNS	20'GP(PCS)	40'GP(PCS)	40HQ(PCS)
24.02"x16.14"x19.69"	35.01	44.09	80	20	820	1720	2030

## ■ INSTALLATIONS

1. Use a screw driver to unscrew the lamp screws and remove the upper half of the fixture.

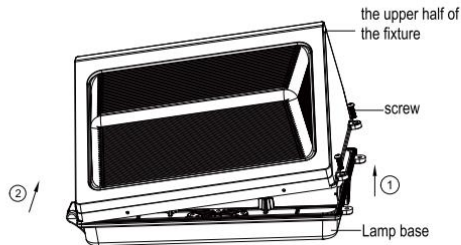

2. Unscrew the cover of the entry hole on the lamp base and remove the cover.

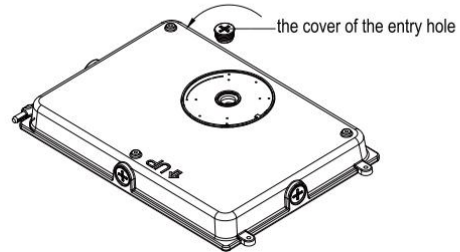

3. According to the embedded terminal box, punch the corresponding mounting hole on the light's mount.

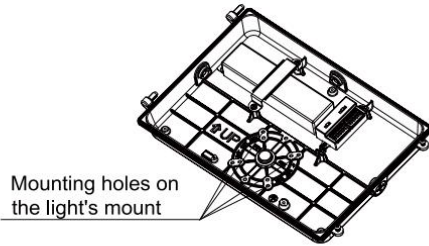

4. Put the input line in the embedded box passes through the waterproof pad and then passed through the lamp base.

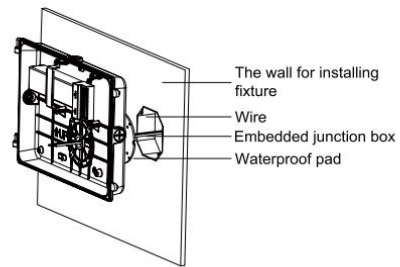

5. Use screw to lock the lamp base on the embedded junction box.

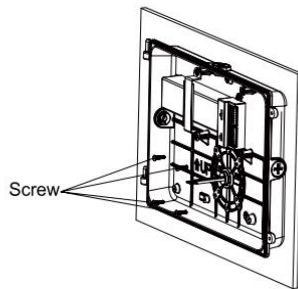

6. Connect the input wire and the dimming wire of the light, then put the connected wires into the embedded terminal box.

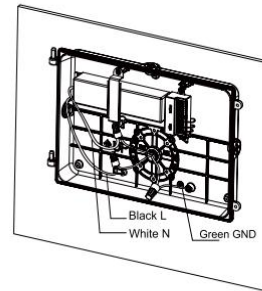

7. Connect the output wires of driver with the wires of PCB board.

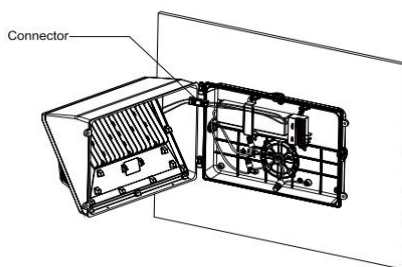

8. Use screws to lock the fixture. Installation completed.

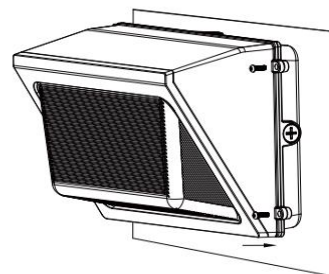

## PHOTOMETRIC DATA

DM-WP45/60/80W-3545K-A	
Minimum Watt	45 W
Maximum Watt	80 W
PF	0.9
CRI	80
THD	15%
Flux	11200lm
Efficacy (AC)	140 lm/W
Minimum CCT	3500K
Maximum CCT	5000K
Voltage Range	120-277 V
Working temperature	-4° F~113° F
Storage temperature	-22° F~140° F

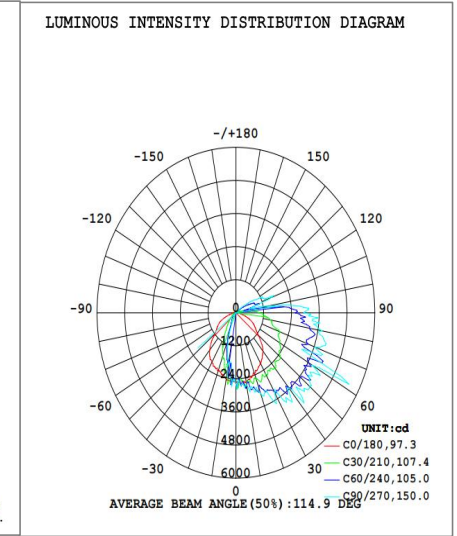
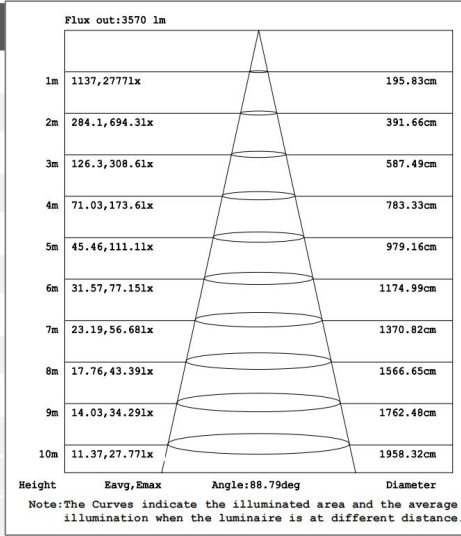

DM-WP60/80/100W-3545K-A	
Minimum Watt	60 W
Maximum Watt	100 W
PF	0.9
CRI	80
THD	15%
Flux	13800 lm
Efficacy (AC)	138 lm/W
Minimum CCT	3500K
Maximum CCT	5000K
Voltage Range	120-277 V
Working temperature	-4° F~113° F
Storage temperature	-22° F~140° F

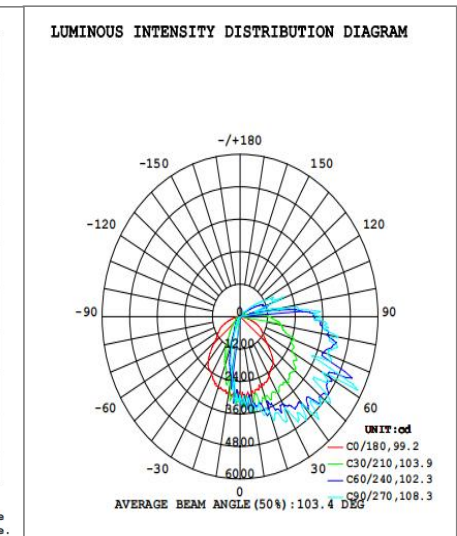
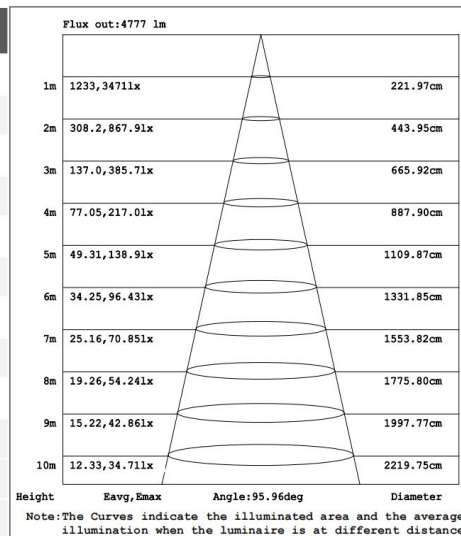

DM-WP80/100/120W-3545K-A	
Minimum Watt	80 W
Maximum Watt	120 W
PF	0.9
CRI	80
THD	15%
Flux	16560lm
Efficacy (AC)	138 lm/W
Minimum CCT	3500K
Maximum CCT	5000K
Voltage Range	120-277 V
Working temperature	-4° F~113° F
Storage temperature	-22° F~140° F

